

Datasheet

Defender S

3 Phase Distribution Board



NDB54P250GR



Main Switch Rating	250 A
Distribution Board Specifications	
Colour Available	Grey (White and Orange on request only)
IP Rating	IP42
Construction	Mild Steel
Height	1000 mm or 1200 mm
Width	600 mm
Depth	130 mm
Poles	18P to 54P
Earth and Neutral Bars Pole	30P or 60P
DIN Rail Size	24 Modules (Top and bottom)
Aluminium cable gland (plate)	Top / Bottom
Split Chassis option	Up to 60P
Document Holder	Yes
Locking System	Key Lock
Reversible Door/Escutcheon	Yes
Cable Duct	Yes (Removable)
Escutcheon	Yes (with 2 DIN cut-out)

Chassis Specifications	
Rated operational voltage (Ue)	415 V
Rated insulation voltage (Ui)	500 V
Rated current of assembly (InA)	250 A
Rated impulse withstand (Uimp)	4 kA
Rated short circuit withstand (Icw)	22 kA / 0.1 sec
Chassis sizes available	12P, 18P, 24P, 30P, 36P, 42P, 48P, 54P
IP Rating	IP20
Compliance	AS/NZS 61439.2

Note: All the images and drawings are for reference only.

Defender S 3 Phase Distribution Board



Cat. No	Description
Distribution board	
Grey	
NDB18P250GR	DEFENDER S - 18 POLE DISTRIBUTION BOARD 250A 2 DIN IP42 - GREY
NDB24P250GR	DEFENDER S - 24 POLE DISTRIBUTION BOARD 250A 2 DIN IP42 - GREY
NDB36P250GR	DEFENDER S - 36 POLE DISTRIBUTION BOARD 250A 2 DIN IP42 - GREY
NDB48P250GR	DEFENDER S - 48 POLE DISTRIBUTION BOARD 250A 2 DIN IP42 - GREY
NDB54P250GR	DEFENDER S - 54 POLE DISTRIBUTION BOARD 250A 2 DIN IP42 - GREY
Orange	
NDB18P250X15	DEFENDER S-18 POLE DISTRIBUTION BOARD 250A 2 DIN IP42 - ORANGE X15
NDB24P250X15	DEFENDER S-24 POLE DISTRIBUTION BOARD 250A 2 DIN IP42 - ORANGE X15
NDB36P250X15	DEFENDER S-36 POLE DISTRIBUTION BOARD 250A 2 DIN IP42 - ORANGE X15
NDB48P250X15	DEFENDER S-48 POLE DISTRIBUTION BOARD 250A 2 DIN IP42 - ORANGE X15
NDB54P250X15	DEFENDER S-54 POLE DISTRIBUTION BOARD 250A 2 DIN IP42 - ORANGE X15
White	
NDB18P250WE	DEFENDER S - 18 POLE DISTRIBUTION BOARD 250A 2 DIN IP42 - WHITE
NDB24P250WE	DEFENDER S - 24 POLE DISTRIBUTION BOARD 250A 2 DIN IP42 - WHITE
NDB36P250WE	DEFENDER S - 36 POLE DISTRIBUTION BOARD 250A 2 DIN IP42 - WHITE
NDB48P250WE	DEFENDER S - 48 POLE DISTRIBUTION BOARD 250A 2 DIN IP42 - WHITE
NDB54P250WE	DEFENDER S - 54 POLE DISTRIBUTION BOARD 250A 2 DIN IP42 - WHITE
Extension boxes	
Grey	
NDB1EXT250GR	DEFENDER S - EXTENSION BOX 1 DIN IP42 - GREY
NDB2EXT250GR	DEFENDER S - EXTENSION BOX 2 DIN IP42 - GREY
Orange	
NDB1EXT250X15	DEFENDER S - EXTENSION BOX 1 DIN IP42 W/O ESCUTCHEON - ORANGE X15
NDB2EXT250X15	DEFENDER S - EXTENSION BOX 2 DIN IP42 W/O ESCUTCHEON - ORANGE X15
White	
NDB1EXT250WE	DEFENDER S - EXTENSION BOX 1 DIN IP42 W/O ESCUTCHEON - WHITE
NDB2EXT250WE	DEFENDER S - EXTENSION BOX 2 DIN IP42 W/O ESCUTCHEON - WHITE
Chassis	
HCH12P250T	12 POLE Encapsulated chassis 250A
HCH18P250T	18 POLE Encapsulated chassis 250A
HCH24P250T	24 POLE Encapsulated chassis 250A
HCH30P250T	30 POLE Encapsulated chassis 250A
HCH36P250T	36 POLE Encapsulated chassis 250A
HCH42P250T	42 POLE Encapsulated chassis 250A
HCH48P250T	48 POLE Encapsulated chassis 250A
HCH54P250T	54 POLE Encapsulated chassis 250A
204639	Main Switch

NDB2EXT250GR



Header Box

HCH36P250T

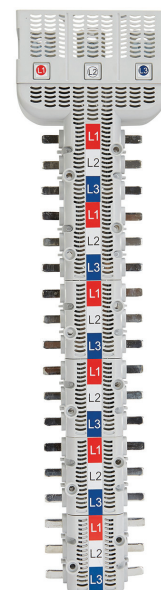

Note: All the images and drawings are for reference only.

Defender S 3 Phase Distribution Board



DIMENSIONS

NDB54P250GR

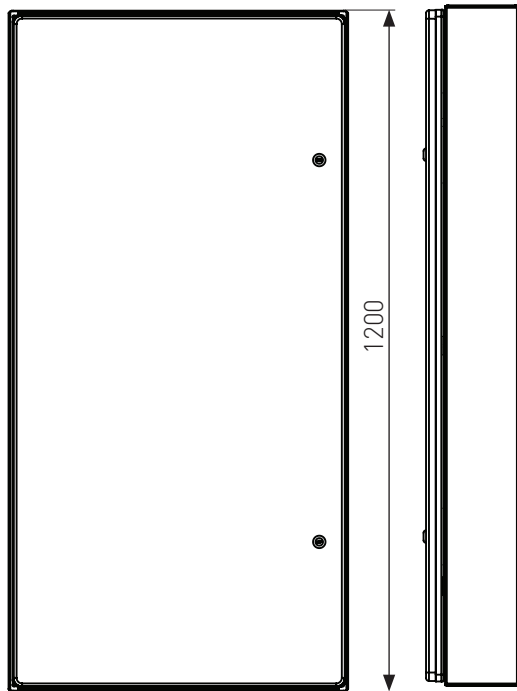

Front View with Door

Right View

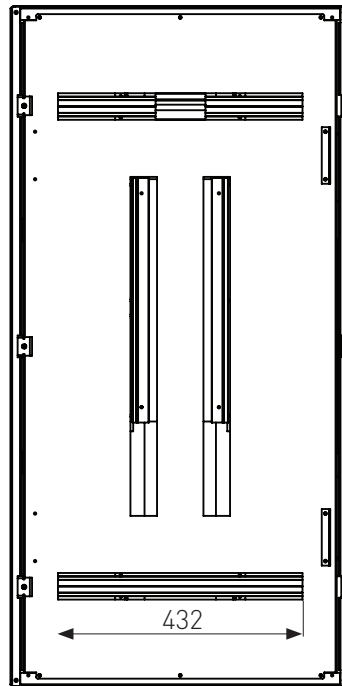

Front View without Door

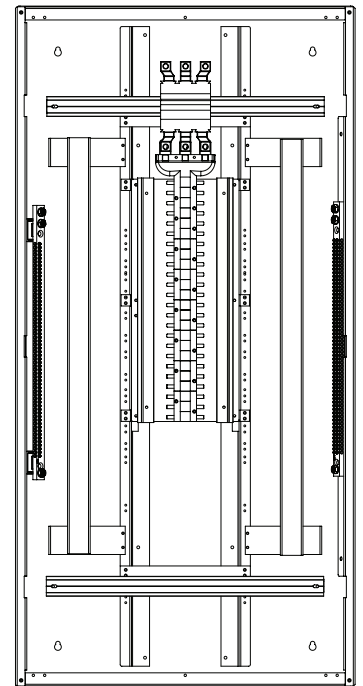

Front View Without Door & Escutcheon

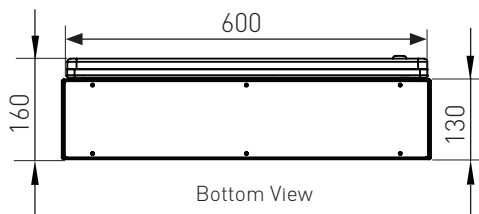

Bottom View

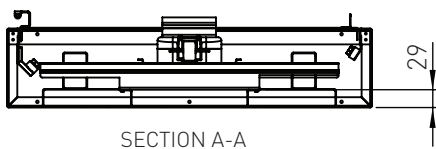

SECTION A-A

Earth Neutral Busbars

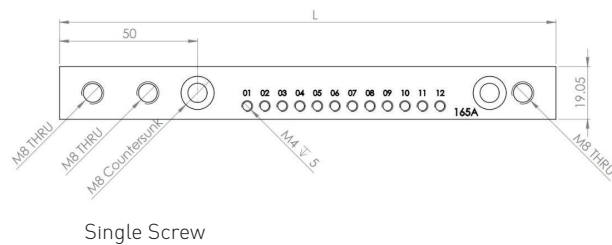

Single Screw

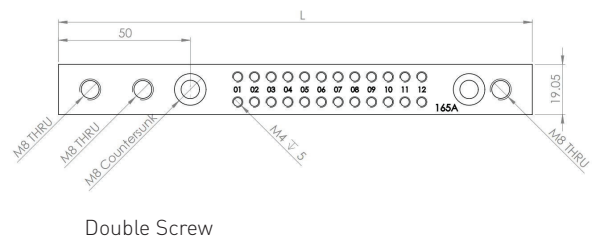

Double Screw

LENGTH (L) mm
176
252
328
404
481
557

Note: All the images and drawings are for reference only.

Note: All dimensions are in mm.

Defender S 3 Phase Distribution Board



NDB2EXT250GR

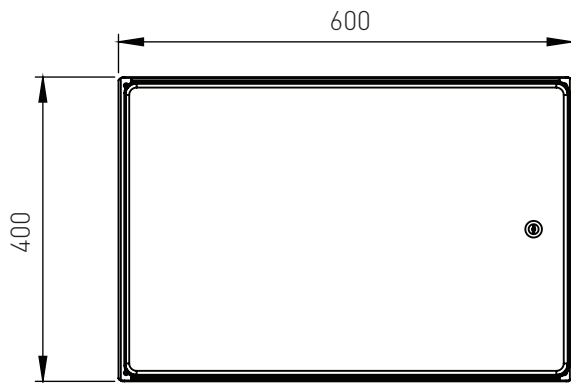

Front View with Door

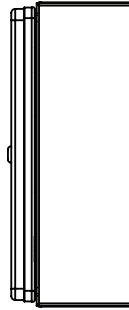

Right View

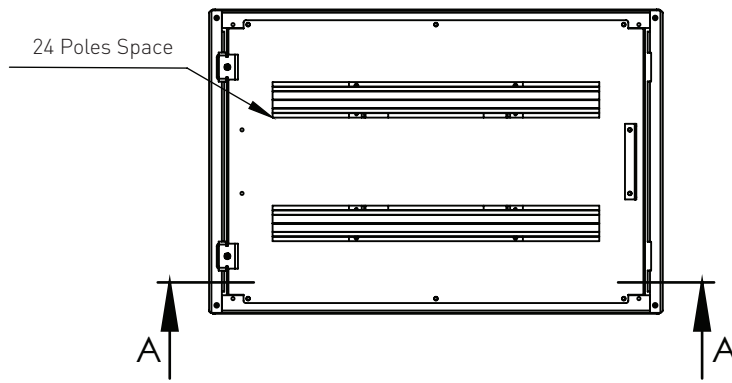

Front View without Door

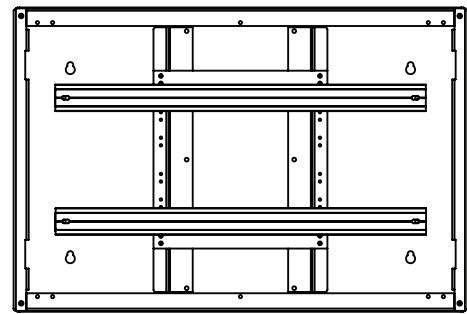

Front View Without Door & Escutcheon

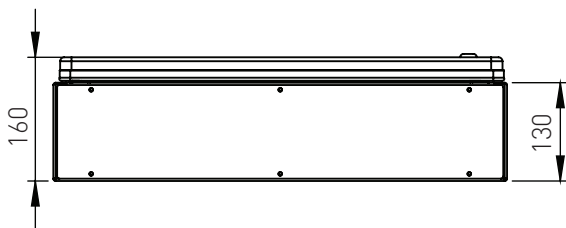

Bottom View

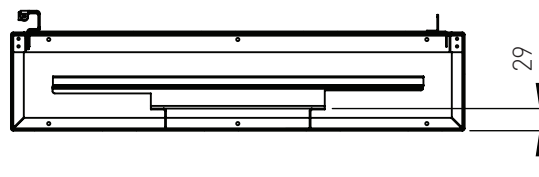

SECTION A-A

Note: All dimensions are in mm.

Note: All the images and drawings are for reference only.

Defender S

3 Phase Distribution Board



Cat. No	Description
Accessories	
NDBGP600A	ALUMINIUM CABLE GLAND PLATE 600MM W
NDBMC525	ALUMINIUM DIN RAIL 24 MODULES
NDB018-36X15	DISTRIBUTION BOARD 2 DIN W/O CHASSIS 1000MM IP42 - ORANGE X15
NDB018-36GR	DISTRIBUTION BOARD 2 DIN W/O CHASSIS 1000MM IP42 - GREY
NDB018-36WE	DISTRIBUTION BOARD 2 DIN W/O CHASSIS 1000MM IP42 - WHITE
NDB048-54X15	DISTRIBUTION BOARD 2 DIN W/O CHASSIS 1200MM IP42 - ORANGE X15
NDB048-54GR	DISTRIBUTION BOARD 2 DIN W/O CHASSIS 1200MM IP42 - GREY
NDB048-54WE	DISTRIBUTION BOARD 2 DIN W/O CHASSIS 1200MM IP42 - WHITE
NDBHD18-36GR	DEFENDER S - HINGED DOOR WITH LOCKS 1000MM - GREY
NDBHD48-54GR	DEFENDER S - HINGED DOOR WITH LOCKS 1200MM - GREY
NDBHD18-36X15	DEFENDER S - HINGED DOOR WITH LOCKS 1000MM - ORANGE X15
NDBHD48-54X15	DEFENDER S - HINGED DOOR WITH LOCKS 1200MM - ORANGE X15
NDBHD18-36WE	DEFENDER S - HINGED DOOR WITH LOCKS 1000MM - WHITE
NDBHD48-54WE	DEFENDER S - HINGED DOOR WITH LOCKS 1200MM - WHITE
NDBE1DIN	DEFENDER S - BLANK ESCUTCHEONS FOR EXTENSION BOX - 1 DIN
NDBE2DIN	DEFENDER S - BLANK ESCUTCHEONS FOR EXTENSION BOX - 2 DIN
NDBHDEXTGR	DEFENDER S - HINGED DOOR WITH LOCKS FOR EXTENSION BOX - GREY
NDBHDEXTWE	DEFENDER S - HINGED DOOR WITH LOCKS FOR EXTENSION BOX - WHITE
NDBHDEXTX15	DEFENDER S-HINGED DOOR WITH LOCKS FOR EXTENSION BOX - ORANGE X15
NDBE18-36	DEFENDER S - BLANK ESCUTCHEONS 1000MM SIZE
NDBE48-54	DEFENDER S - BLANK ESCUTCHEONS 1200MM SIZE
NDB39336S	BUSBAR 36 POLE EARTH BAR 3XM8 BOLTS
NDB39336D	BUSBAR 36 POLE NEUTRAL BAR 3XM8 BOLTS
NDB39360S	BUSBAR 60 POLE EARTH 3XM8 BOLTS
NDB39360D	BUSBAR 60 POLE NEUTRAL 3XM8 BOLTS
NDBDINBRKT	BRACKET TO MOUNT DIN RAILS
NDBPANBRKT	BRACKET TO MOUNT CHASSIS TO THE BOARD
NDBPANBASE18	DEFENDER S - PAN BASE FOR 18 POLE
NDBPANBASE24	DEFENDER S - PAN BASE FOR 24 POLE
NDBPANBASE36	DEFENDER S - PAN BASE FOR 36 POLE
NDBPANBASE48	DEFENDER S - PAN BASE FOR 48 POLE
NDBPANBASE54	DEFENDER S - PAN BASE FOR 54 POLE
NDBLBK144	LOCK AND BARREL - KEY INCLUDED
NDBGFH	HINGES FOR DISTRIBUTION BOARD DOORS
NDBENBS	PLASTIC EARTH NEUTRAL BUSBAR BRACKET
NDBCHA4	PLASTIC PAPER HOLDER WITH TAPE
NDBMLD28	POLE FILLERS - BLANK MCB
NDBCL24TP	CIRCUIT ID LABELS ON ESCUTCHEON
NDBEXTPCOV	EXTENSION STRIP - FOR POLE COVERING 3M LENGTH

Legrand Australia
1300 369 777
www.legrand.com.au
ABN 31 000 102 661

Legrand New Zealand
0800 476 009
www.legrand.co.nz

Refer to your group buying office, Legrand Sales Representative or Legrand Sales Office for pricing.

Please note: specifications are subject to change without prior notice.



LE12529AA

09 / 2020